

SWEDISH • AUDIO • PASSION

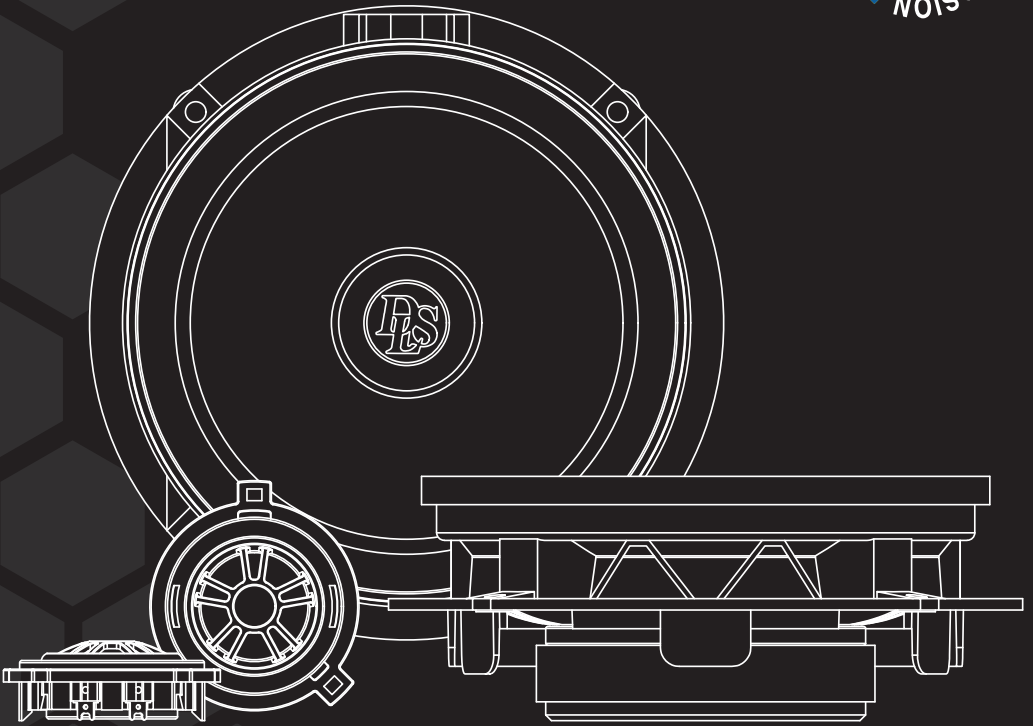

CRPP-2.6

User manual

Seat / Skoda / VW



CRUISE

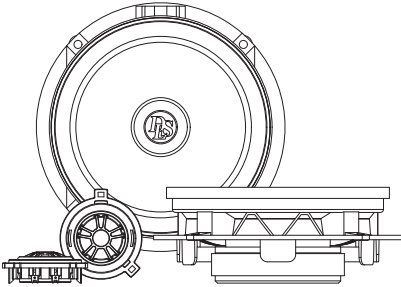

Welcome to DLS!

Thank you for buying a DLS Cruise CRPP-2.6. For us, it's all about the sound experience. We care deeply about sound and construction quality. In order for your experience to be as optimal as possible, it is important that you fully read this manual, preferably before you start your installation. Keep the manual in a safe and accessible place for future reference.

Your speakers must be installed correctly in order to work as intended. Make sure you have all necessary tools nearby before starting and that you are completely confident in how to proceed. If you feel the slightest uncertainty; feel free to take the help of an experienced installer or a car audio dealer.

Warranty

This component kit is covered by warranty, depending on the conditions in the country where it is sold. If the speaker is returned for service, please include the original dated receipt with the product.

General

Some sound systems may vary in size of the door speaker. Make sure that your vehicle has the same size as this kit, before you start the assembly

This is a generic mounting instruction. The approach is similar to all of the described car models. Some screws and clips may be placed differently and depending, if the tweeter is placed in the A-pillar or side mirror, the course of action may vary.

DECLARATION OF CONFORMITY

DLS plug and play speakers for vehicles are manufactured in accordance with the EU directive EEC 95/54 (72/245/EEC) and are marked with the approval number. They are also marked in accordance with the WEEE-directive 2012/19/EC. The products are also produced in accordance with the EU RoHS directive 2015/863/EU.

DLS CRUISE CRPP-2.6

Content

Welcome	1
Pre installation	2
General info	2
Installation	2
Start the dismount	2
Removing woofer	3
Mounting drivers	3
Change tweeter	4
Remove old tweeter	5
Running-in time	6
DLS support	6
Specification woofer	7
Specification tweeter	7
Compatible car models	8
Product markings	10

DLS speakers are engineered by DLS Sweden,
a part of:

Winn Scandinavia AB

Elementvägen 15 - SE-702 27 Örebro - Sweden

Tel: +46 19 20 67 65 - E-mail: info@dls.se

www.dls.se

Designed & Sound tuned in Sweden.



Included products:

2pcs Woofers
2pcs Tweeters
2pcs Crossovers

Included accessories:

2pcs Tweeter connections
4pcs Adhesive foams for wrapping
4pcs Terminal crimp connectors
2pcs Four-leaf clover foams for tweeter
10pcs Blind rivets
1pc Rivet Tool
1pc PRY tool
1pc Manual

Pre installation

Disconnect Battery

Before you start the process of replacing speakers, disconnect and secure the negative terminal from your battery/power source. This will prevent the risk of damaging yourself or the products.

Place the disconnected terminal in a secure and isolated location away from any possible connection belonging to the battery/power source system.

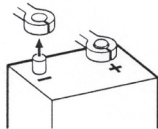

General info

Some sound systems may vary in size of the door speaker. Make sure that your vehicle has the same size as this kit, before you start the assembly

This is a generic mounting instruction. The approach is similar to all of the described car models. Some screws and clips may be placed differently and depending, if the tweeter is placed in the A-pillar or side mirror, the course of action may vary.

Be careful when removing the panels and lids, so there will be no marks. Use plastic PRY tools to avoid marks on the panels and destroy the plastic clips.

Installation

Start the dismant

Dismount the front door by removing the cover of the door panel.

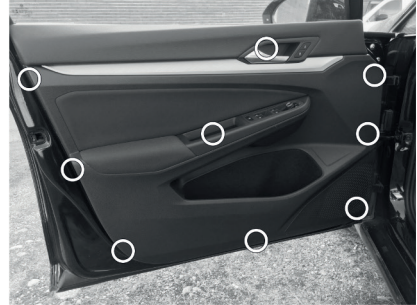

Usually the clips/screws are placed by the white marks. It may be different in your vehicle.



In most cases the screws used are Torx T30. Unscrew them and store them in a safe position, to re-use when re-mounting the door panel.

Use a wrench, size 10. Normally the bolt is located at the underside of the door. Turn bolt 90 degrees.





When the door panel is loose, start with softly lifting it straight up, to remove the panel.

There are several electric and mechanical connectors on the backside of the panel. Release the door lock cable



Disconnect the window control panel, cables for lights, speaker cable harness and any other connections.

Removing woofer

The door speakers are fixed with rivets.

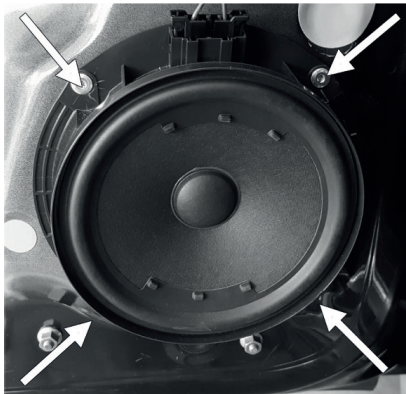

Use a 4mm drill to remove the rivets. Make sure all remains from the old rivets are removed from the inside of the door.

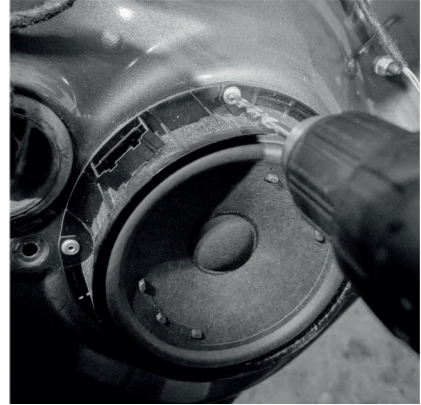

Just drill enough to remove the top of the rivets

Mounting DLS drivers

Place the new DLS driver in the hole for the speaker. Use the included rivets and the rivet tool to safely mount the driver. (Step 3 might be done several times)

1. Insert rivet
2. Plug in the rivet tool



3. Press handles
4. Remove the pin

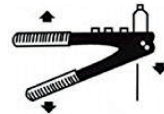

Connect the speaker harness.

Start the assembly of the door panel. Reconnect all wires harness.

Connect all plugs to the door cover, reconnect the unlocking device, place the door cover from the top, by the window seal and push it gently down. Make sure the clips are in place and can engage. Give the door panel a push by the hand to attach to the clips. Mount and fasten all screws to the correct places.



Change Tweeter

Locate the tweeter - Either in the A-pillar, by the side mirror or in some case in the door by the handle.



A-Pillar



Side mirror

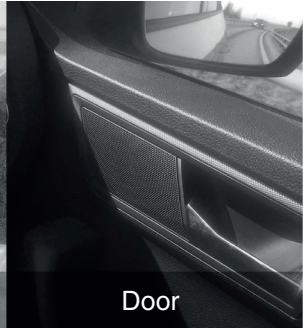

Door

Dismount over and remove the covers. Use Plastic PRY tools and be careful, there can be air-bags behind the A-Pillar. The first clip can be really hard to remove. Take it easy and use minimal force. (This shows how to unmount the A-pillar tweeter)



Un-clip the speaker connector from tweeter

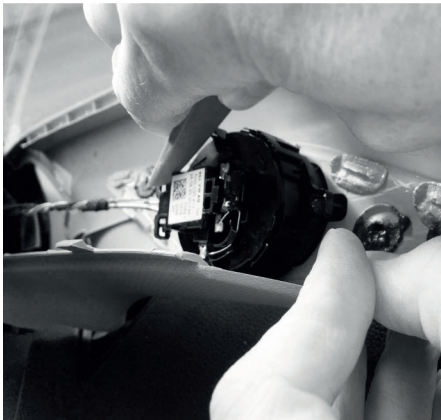



Remove old tweeter

Use a cutting nipper or a Snap-off blade knife to remove the top of the plastic pin that holds the tweeter. Don't remove the whole pin, just the top!

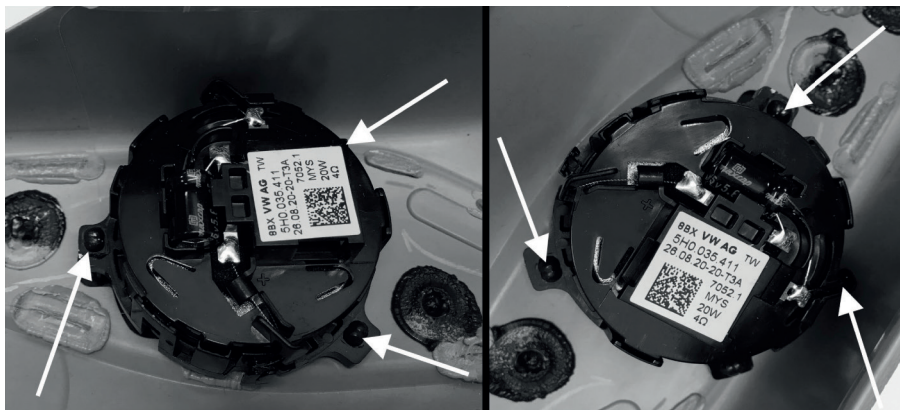

Change the tweeter, and place it where the OEM tweeter used to be. Make sure that the DLS tweeter is properly fixed. Remove the protecting plastic sheet from the adhesive four-leaf clover and use it to hold the new tweeter in place. Make sure the tweeter is fixed in a safe way.

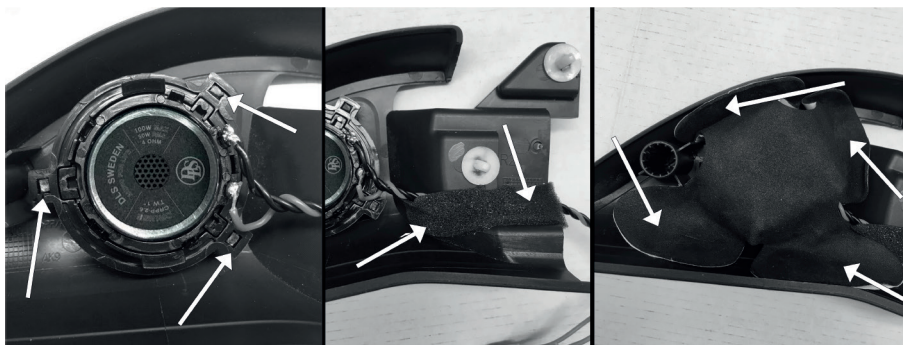

For some models, the four-leaf clover needs to be adapted. Use a sharp scissor to modify it.





Connect the crossover with the PnP connector. Use the other adhesive foam to secure the crossover and cables

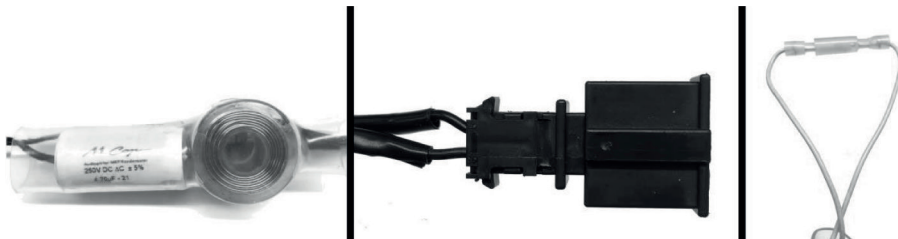

The yellow cable loop is tweeter level select, enabling fine tuning of the high frequencies
Closed loop = -4dB (Shown in the picture)
Open loop = Normal

Finally

Start assembling the covers again to finish the work. Make sure that no screws or clips are left over, Reconnect the battery/power source terminal.

Finally, it's time to play some good music and enjoy!

Running-in time

Allow the component kit to play for at least 15-20 hours in order to perform at its possibly best. This run-in can be made with tone sweep or with just music.

Start at a moderate volume and increase the volume step by step during the running in period. After the 15-20 hour run in session the performance and characteristics will be in the correct condition.



DLS Support

For technical assistance, ask your car audio dealer where the product was sold or the distributor in your country. You can always contact the DLS Helpdesk in Sweden at e-mail: info@dls.se Information can also be found on our WEB-site www.dls.se We follow a policy of continuous advancement in development. For this reason, all or part of specifications & designs may be changed without prior notice.



Specifications

Art. no CK-CRPP-2.6

Woofer 6.5" /165mm with glass fiber cone
 Tweeter 1" / 25mm silk dome tweeter with accessories
 RMS Power 100W
 MAX Power 200W
 Impedance 3 Ohm
 Sensitivity 90dB 1W/1M
 Freq. range 55Hz-25kHz
 Crossover 4.8kHz 12dB/Oct with Mundorf caps
 Attenuation Tweeter -4dB/0dB

Electro-Acoustic Parameters Tweeter:

Re 3.5 Ohm
 Fs 1992Hz
 SPL 94dB 1W/1M

DLS CRPP-2.6 Tweeter

Technical Specification

Size 1" /25mm
 RMS Power 50W
 MAX Power 100W
 Voice Coil Material CCAW voice coil/ Aluminum former
 Frame Glass Fiber Reinforced ABS
 Magnet Neodymium/Copper shorting ring
 Cone Natural silk dome
 Impedance 4 Ohm
 Freq. range 2000Hz-25kHz

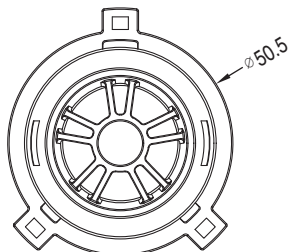
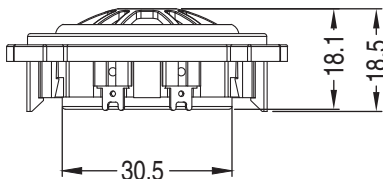

DLS CRPP-2.6 Woofer

Technical Specification

Size 6.5" /165mm
 RMS Power 100W
 MAX Power 200W
 Voice Coil Size 1" /25mm
 Voice Coil Material CCAW voice coil/ Kapton former
 Basket Glass Fiber Reinforced ABS
 Magnet Ferrite/Copper shorting ring
 Cone Glass Fiber
 Suspension Rubber
 Impedance 3 Ohm
 Freq. range 55Hz-5kHz

Electro-Acoustic Parameters

Re 2.4 Ohm
 Fs 68.4Hz
 Mms 12.6g
 Cms 0.427
 Vas 11.6L
 Qts 0.74
 Qes 0.85
 Qms 6.3
 Bl 3.96T.m
 Spl 88.5dB 1W/1M
 Sd 132cm²

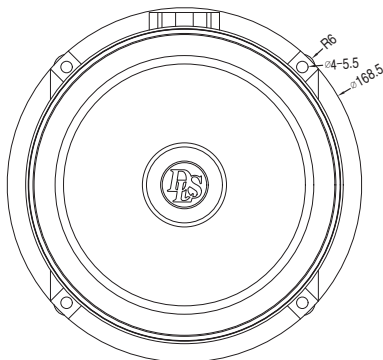
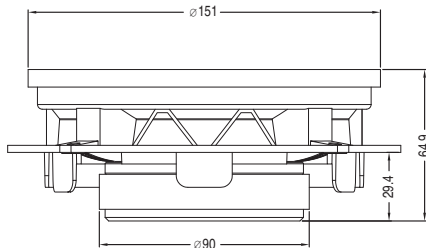



Impedance VS Frequency

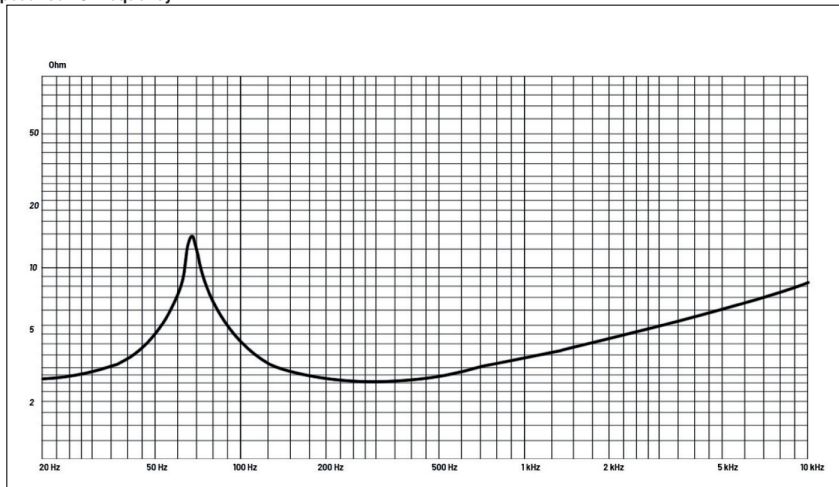

DLS Cruise CRPP-2.6 compatible car models

Car	Model	Year	Front speaker	Rear speaker
MAN	TGE	2017-2022	CRPP-2.6*	
SEAT	ALTEA	2004-2015	CRPP-2.6*	CRPP-2.6CX**
SEAT	ALTEA XL	2004-2015	CRPP-2.6*	CRPP-2.6CX**
SEAT	ARONA	2018-2021	CRPP-2.6*	CRPP-2.6CX**
SEAT	AROSA	1997-2004	CRPP-2.6*	
SEAT	ATECA	2016-2021	CRPP-2.6*	CRPP-2.6CX**
SEAT	CORDOBA II	2002-2009	CRPP-2.6*	CRPP-2.6CX**
SEAT	IBIZA III	2001-2008	CRPP-2.6*	CRPP-2.6CX**
SEAT	IBIZA IV	2008-2017	CRPP-2.6*	
SEAT	IBIZA V	2018-2021	CRPP-2.6*	CRPP-2.6CX**
SEAT	LEON	2000-2005	CRPP-2.6*	
SEAT	LEON II	2006-2012	CRPP-2.6*	CRPP-2.6CX**
SEAT	MII	2012-2021	CRPP-2.6*	
SEAT	TOLEDO II	1994-2004	CRPP-2.6*	
SEAT	TOLEDO III	2004-2009	CRPP-2.6*	CRPP-2.6CX**
SEAT	TOLEDO IV	2012-2019	CRPP-2.6*	
SKODA	CITIGO	2012-2021	CRPP-2.6*	CRPP-2.6CX**
SKODA	FABIA I	1999-2007	CRPP-2.6*	CRPP-2.6CX**
SKODA	FABIA II	2007-2014	CRPP-2.6*	CRPP-2.6CX**
SKODA	FABIA III	2015-2021	CRPP-2.6*	CRPP-2.6CX**
SKODA	KAMIQ	2019-2021	CRPP-2.6*	CRPP-2.6CX**
SKODA	KAROQ	2018-2021	CRPP-2.6*	CRPP-2.6CX**
SKODA	KODIAQ	2017-2022	CRPP-2.6*	CRPP-2.6CX**
SKODA	OCTAVIA II	2004-2013	CRPP-2.6*	CRPP-2.6CX**
SKODA	OCTAVIA III	2013-2018	CRPP-2.6*	CRPP-2.6CX**
SKODA	ROOMSTER	2006-2015	CRPP-2.6*	CRPP-2.6CX**



SKODA	RAPID	2012-2021	CRPP-2.6*	CRPP-2.6CX**
SKODA	SCALA	2019-2021	CRPP-2.6*	CRPP-2.6CX**
SKODA	SUPERB	2008-2015		CRPP-2.6CX**
SKODA	SUPERB	2016-2021	CRPP-2.6*	CRPP-2.6CX**
SKODA	YETI	2009-2017	CRPP-2.6*	CRPP-2.6CX**
SKODA	YETI II	2018-2021		CRPP-2.6CX**
SKODA	SUPERB	2016-2021	CRPP-2.6*	CRPP-2.6CX**
VW	ARETON	2017-2021		CRPP-2.6CX**
VW	AMAROK	2010-2021	CRPP-2.6*	CRPP-2.6CX**
VW	ATLAS	2010-2021		CRPP-2.6CX**
VW	NEW BEETLE	1997-2011	CRPP-2.6*	CRPP-2.6CX**
VW	BEETLE	2011-2021		CRPP-2.6CX**
VW	BORA	1998-2005	CRPP-2.6*	CRPP-2.6CX**
VW	BORA VARIANT	1999-2005	CRPP-2.6*	CRPP-2.6CX**
VW	C-Trec	2016-2021	CRPP-2.6*	CRPP-2.6CX**
VW	CADDY	2020-2021	CRPP-2.6*	
VW	CRAFTER II	2017-2021	CRPP-2.6*	
VW	EOS	2006-2011		CRPP-2.6CX**
VW	GOLF IV	1997-2004	CRPP-2.6*	CRPP-2.6CX**
VW	GOLF V	2004-2008	CRPP-2.6*	CRPP-2.6CX**
VW	GOLF VI	2008-2014	CRPP-2.6*	CRPP-2.6CX**
VW	GOLF VII	2012-2020	CRPP-2.6*	CRPP-2.6CX**
VW	GOLF VIII	2020-2021	CRPP-2.6*	CRPP-2.6CX**
VW	ID 3	2020-	CRPP-2.6*	
VW	ID 4	2021-	CRPP-2.6*	
VW	JETTA	2005-2010	CRPP-2.6*	CRPP-2.6CX**
VW	JETTA VII	2015-2021	CRPP-2.6*	CRPP-2.6CX**
VW	LAVIDA	2008-2018	CRPP-2.6*	CRPP-2.6CX**
VW	LAVIDA PLUS	2018-2021	CRPP-2.6*	CRPP-2.6CX**
VW	LUPO	1998-2005	CRPP-2.6*	
VW	MAGOTAN	2013-2016	CRPP-2.6*	CRPP-2.6CX**
VW	MAGOTAN	2017-2021		CRPP-2.6CX**
VW	NIVUS	2020-2021	CRPP-2.6*	CRPP-2.6CX**
VW	PASSAT	1996-2005	CRPP-2.6*	CRPP-2.6CX**
VW	PASSAT	2005-2015		CRPP-2.6CX**
VW	PASSAT	2015-2021		CRPP-2.6CX**
VW	POLO IV	2001-2009	CRPP-2.6*	CRPP-2.6CX**
VW	POLO V	2009-2016	CRPP-2.6*	CRPP-2.6CX**
VW	POLO VI	2017-2021	CRPP-2.6*	CRPP-2.6CX**
VW	NEW SANTANA	2012-2021	CRPP-2.6*	CRPP-2.6CX**
VW	SCIROCCO	2008-2017	CRPP-2.6*	CRPP-2.6CX**
VW	T6.1 MULTIVAN	2020-2021	CRPP-2.6*	
VW	TAREK	2018-2021	CRPP-2.6*	CRPP-2.6CX**
VW	TAYRON	2019-2021		CRPP-2.6CX**
VW	TERAMONT	2018-2021		CRPP-2.6CX**
VW	THARU	2018-2021	CRPP-2.6*	CRPP-2.6CX**
VW	TIGUAN	2007-2021	CRPP-2.6*	CRPP-2.6CX**
VW	TOURAN	2003-2021		CRPP-2.6CX**
VW	T-CROSS	2019-2021	CRPP-2.6*	CRPP-2.6CX**
VW	T-ROC CAB	2020-2021	CRPP-2.6*	CRPP-2.6CX**
VW	T-ROC	2017-2021	CRPP-2.6*	CRPP-2.6CX**
VW	UP E-UP!	2011-2021	CRPP-2.6*	CRPP-2.6CX**
VW	VENTO	2010-2020	CRPP-2.6*	CRPP-2.6CX**

Disclaimer

* DLS CRPP-2.6 is not compatible if your vehicle is with the original Premium Hi-fi system/Dynaudio system/Fender Audio system, or sound system with 8" speakers.

** DLS Recommends CRPP-2.6CX as rear speaker. CRPP-2.6 kit may fit in rear doors if there is a tweeter location.



Product markings



The crossed-out wheelee bin symbol means that the product, literature and packaging included must be taken to separate collection at the end of their working life. Do not dispose of these products as unsorted municipal waste: take them for recycling. For info on your nearest recycling point, check with your local waste authority.



This product has been granted with the CE certification mark to show that the product follows the health, safety, and environmental protection standards for products sold within the European Economic Area (EEA).



DLS products complies with the relevant provisions of the RoHS Directive for the European Union. In common with all Electrical and Electronic Equipment (EEE) the product should not be disposed of as household waste. Alternative arrangements may apply in other jurisdictions.



DLS is a global partner of the European Mobile Media Association, an organisation that focus on promoting the custom made mobile media installations to consumers.

We follow a policy of continuous advancement in development. For this reason all or part of specifications & designs may be changed without prior notice. We reserve for possible typos, factual or numeric errors that may have been printed on any products, package designs, user manuals and/or other included accessories.



CRUISE **E**