

PA6

6.5" 2-Way Coaxial speaker



Performance Advantage

– The DLS experience at a great value

With durable quality, impressive performance and high flexibility the DLS Performance Advantage series brings you the unique DLS audio experience at a great value.

- High quality entry level 2-way speaker
- Polypropylene cone woofer and rubber surround
- Sand paint-coated steel basket
- High grade Ferrite Motor
- 0,51"/13mm Neodymium tweeter with Mylar cone and 6dB crossover
- Protective grilles, speaker cable and installation accessories included

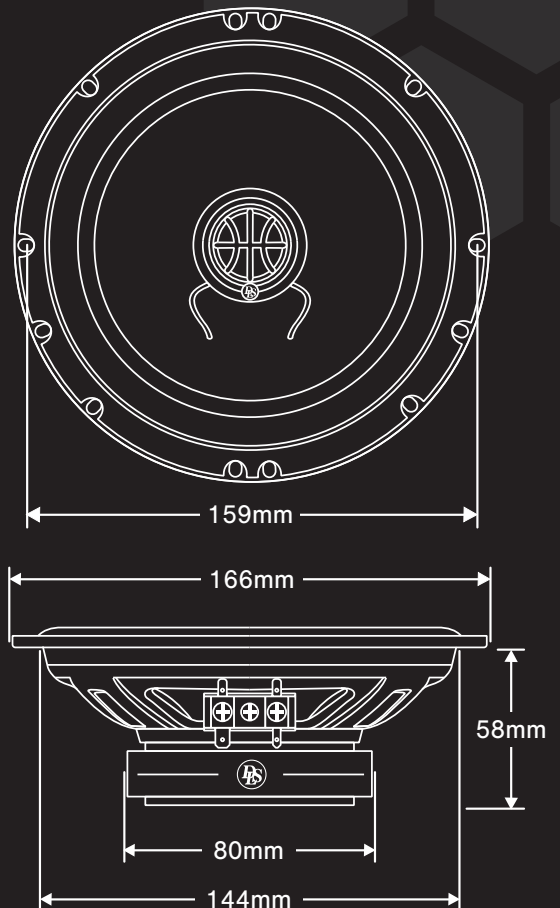

SPECIFICATIONS	
Tweeter	0.51" / 13mm
Woofer	6.5" / 165mm
Power RMS	50W
Power MAX	100W
Power PEAK	150W
Impedance	3 Ohm
Sensitivity	86 dB
Freq.range	67-20 000 Hz



DLS Sweden, a part of Winn Scandinavia AB

www.facebook.com/dlsaudioofficial

www.dls.se | info@dls.se



PERFORMANCE